

# ASM160 MURPHYMATIC® Micro-controller Installation and Operation Instructions

00-02-0276  
Revised 3-00  
Section 40



Please read the following information before installing. A visual inspection of this product for damage from shipping is recommended before installing. It is your responsibility to have a qualified person install this unit and make sure it conforms to local codes.

## GENERAL INFORMATION

### WARNING

BEFORE BEGINNING INSTALLATION OF THIS MURPHY PRODUCT

- ✓ Disconnect all electrical power to the machine.
- ✓ Make sure the machine cannot operate during installation.
- ✓ Follow all safety warnings of the machine manufacturer.
- ✓ Read and follow all installation instructions.

### Description

The ASM160 is an engine controller with automatic start/stop, and selectable warmup/cooldown or glowplug capabilities.

The ASM160 operates from a 12 or 24 volt battery. It includes crank and rest cycles, sensing circuit for crank disconnect and overspeed, overcrank, and crank protection on false starts. Four LEDs indicate first-out shutdown for: Low Oil Pressure, High Temperature, Overcrank, Overspeed. A fifth LED indicates Engine Running. There are also two (2) spare inputs that will cause the unit to shut down without announcement on the front LED's.

### Specifications

**Power Input:** 12 or 24 VDC.

**Operating Temperature:** -40 to 185°F (-40 to +85°C).

**Inputs:** Ground or positive inputs for High Temperature, Low Pressure, and two spares.

**Lamp and Output Test:** One ground only input for lamp and output test.

**Outputs:** 5 A relay for cranking and fuel valve. 300 mA transistor for fault annunciation, warmup/cooldown, or glowplug.

**Cycle Crank Timer:** Selectable to 3, 5, 10 or infinite attempts.

**Crank/Rest Cycle Timing:** Crank time 10 seconds. Rest time 15 seconds.

**Glow Plug Time Delay:** Field adjustable from 1 to 300 seconds.

**Warmup Time Delay:** Field adjustable from 1 to 300 seconds.

**Cooldown Time Delay:** Field adjustable from 1 to 300 seconds.

**Shutdown Lockout Time Delay:** 15 second lockout for low oil, high temperature, one spare and loss of speed shutdown on start-up.

**Crank Disconnect Speed Setting:** Field adjustable from 30 to 8500 Hz.

**Overspeed Trip Point Setting:** Field adjustable from 30 to 8500 Hz.

**Magnetic Pickup Input:** Requires 3V rms minimum 30 to 100 Hz;  
Requires 2V rms minimum 100 Hz and up; Maximum 35V rms.

### Installation Accessories

- Tools as needed for module mounting, such as drill and screw driver.
- 12 and 14 AWG (4.0 mm<sup>2</sup> and 2.5 mm<sup>2</sup>) wire for hook up.
- Set of wire termination tools.
- Wire termination; such as spade terminals.

### ASM160 Mounting Dimensions

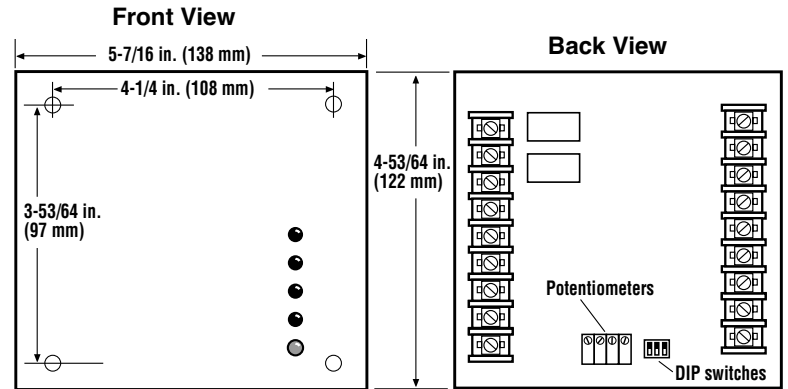

### Mounting Drill Pattern

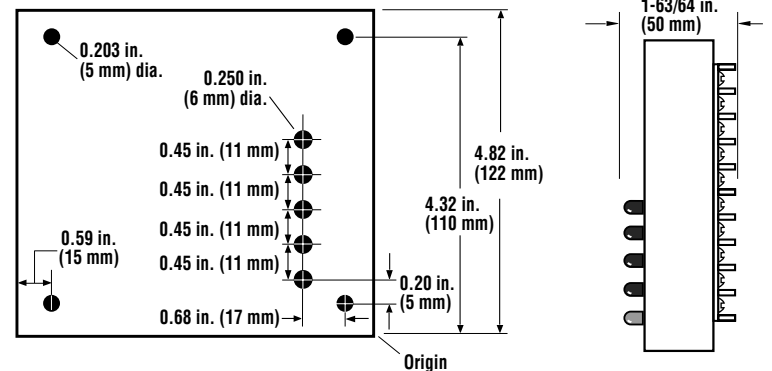

### Mounting the ASM160 Module

1. To mount the ASM160 module to a panel, drill five (0.250 in. [6 mm] dia.) holes for LED indicators and four (0.203 in. [5 mm] dia.) holes for the mounting screws. See "Mounting Drill Pattern", above, for dimensions.
2. Insert the ASM160 module from the back of the panel into the pre-drilled holes. See schematic below.
3. Secure the module in place with the four mounting screws provided.
4. Make sure the panel is clean and free of oil. Remove the adhesive cover from the back of the ASM160 label. Position the label on the panel and press firmly.

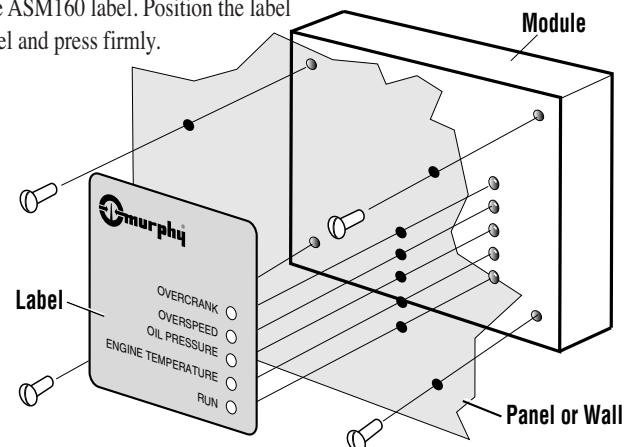

## WIRING THE ASM160

**WARNING:** Disconnect ALL electrical power before beginning the wiring. STOP ALL machinery before performing the hook up. Any load connected to the panel which exceeds current ratings MUST be piloted at the load.

The ASM160 is a pilot duty device. The outputs are designed for control only.

1. Wire the ASM160, using 14 AWG (2.5 mm<sup>2</sup>) stranded wire. When wiring to terminal 18 (the common power for the external relay loads), we suggest using larger wire size (12 AWG [4.0 mm<sup>2</sup>]).
2. When hooking the battery positive (+) and ground wires to the ASM160, route them directly from the battery to the unit. This will help reduce electrical noise coupling and avoid voltage losses from other devices.
3. If a standby battery charger is installed, it must be wired directly to the battery, NOT to the ASM160. This could cause electronic "noise" produced by the charger to be coupled into the microprocessor. If the "noise" is severe, erratic operation will occur.
4. Do not route low voltage DC (battery) control wires in the same conduit as high voltage AC wires.
5. Use shielded cable for connecting the magnetic pickup to the ASM160. Ground only one end of the shield (suggest to ground it at the engine).
6. Always place reverse bias diodes across inductive loads (see "Typical Wiring Diagram", Note: 2, below). This increases the contact life and helps eliminate a source of electromagnetic noise.
7. Output terminals 1 and 2 are rated for 5 A. Output terminals 3, 4, 5, 6, 7 and 8 are rated for 300 mA sinking.

### Typical Wiring Diagram

NOTES: [1] Close to start and run, open to stop.

[2] For Pilot Duty Only. External Load not to exceed 5 A.  
Place reverse bias diodes across induction loads.

[3] Remote lights (if used) not to exceed 300 mA.

[4] At Load/Glow Plug Relay not to exceed 300 mA.

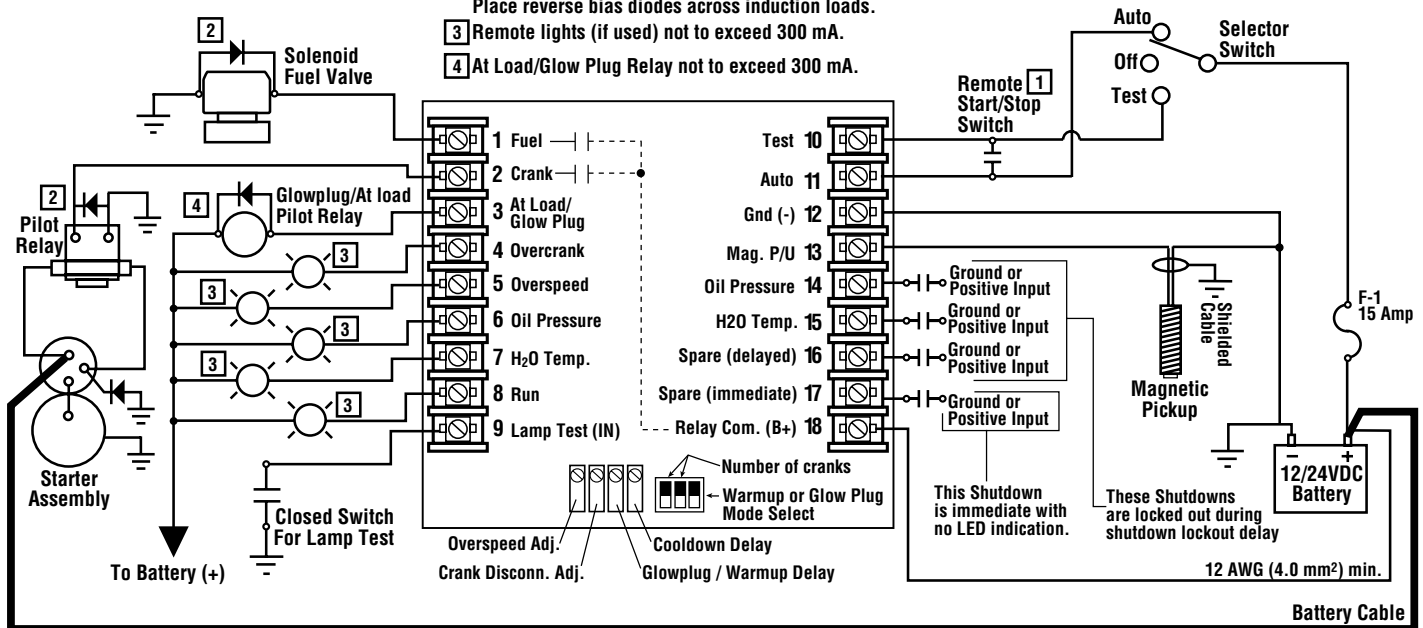

## MAKING ADJUSTMENTS TO THE ASM160

On the back of the ASM160, you will find four (4) potentiometers and three (3) DIP switches for customizing your controller. The four potentiometers are designated as follows:

- R1 = Overspeed Adjustment (30-8500 Hz)
- R2 = Crank Disconnect Adj. (30-8500 Hz)
- R3 = Glow Plug or Warmup Delay (1-300 seconds)
- R4 = Cooldown Delay (1-300 seconds) not used when Glow Plug feature is selected.

### ASM160 Module Back View Detail

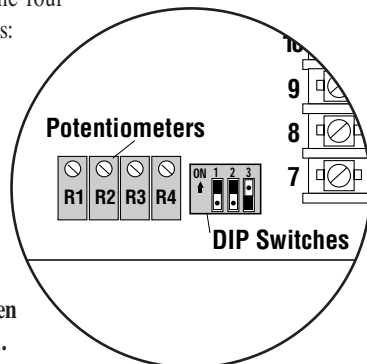

### Overspeed (R1 Pot)

The OVERSPEED pot is used to set the point at which the unit will signal for a shutdown if the engine speed should reach excessive RPM. To set the OVERSPEED value, turn the OVERSPEED Pot (R1) fully clockwise and run the engine up to the maximum operating speed. Next, slowly turn the Pot (R1) counterclockwise until the engine shuts down on OVERSPEED. Now, turn Pot (R1) clockwise two turns. This will adjust the OVERSPEED set-point slightly higher than the maximum engine operating speed.

### Potentiometer Detail

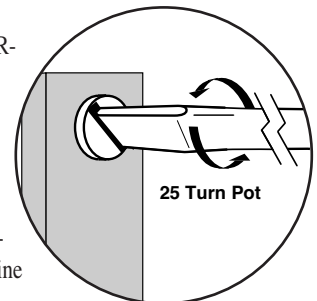

**Crank Disconnect (R2 Pot)**

The CRANK DISCONNECT adjustment is used to let the ASM160 know when the engine has started so that it will disengage the starter. First, set the throttle at fast idle. Now, turn the **Pot (R2)** fully clockwise, loosen the crank wire at **Terminal #2**. Cause the engine to start and immediately disconnect the crank wire (terminal #2) to prevent further cranking. Slowly turn the **Pot (R2)** counter-clockwise until the green light (Engine Running) turns ON. This adjustment must be complete within 90 seconds, or the engine will shut down indicating OVERCRANK. If this happens, simply connect the crank wire (terminal #2), enable starter circuit, manually reset and try again.

**Glow Plug Delay (R3 Pot)** Selected by DIP Switch #3

The GLOW PLUG DELAY adjustment is used to energize the glow plug circuit. The glow plug delay begins timing after the remote auto start signal is received, or the controller is started in "test". During this delay the glow plug output is turned on. When this delay expires, the auto start sequence begins. To increase the setting, turn the **Pot (R3)** clockwise. To decrease the setting, turn the **Pot (R3)** counter-clockwise.

**Warmup Delay (R3 Pot)** Selected by DIP Switch #3

The WARMUP DELAY adjustment is used to energize the warmup/cooldown circuit. The warmup delay begins timing after the engine starts, with the output turning on when delay expires. To increase the setting, turn the **Pot (R3)** clockwise. To decrease the setting, turn the **Pot (R3)** counterclockwise.

**Cooldown Delay (R4 Pot)** Selected by DIP Switch #3

*NOTE: Cooldown delay (Pot R4) functions only when Switch #3 is turned OFF.*

The COOLDOWN DELAY adjustment is used to energize the cooldown circuit. The cooldown delay begins timing after a stop signal is received. To increase the setting, turn the **Pot (R4)** clockwise. To decrease the setting, turn the **Pot (R4)** counterclockwise.

**Overcrank Adjustments (DIP Switches)**

The ASM160 allows you to crank the engine 3, 5, 10 or infinite number of attempts (refer to the **DIP Switch Setting Chart** shown below). If after these attempts the engine fails to start, the ASM160 will signal OVERCRANK. If infinite number of cranks is selected, the Overcrank shutdown will not operate. The engine will cycle crank as long as there is sufficient battery power available.

If the engine fails to start and the ASM160 re-crank's the engine, it will count this as a cranking attempt. This way, if the engine false starts the same number of times as the selected cranking attempts, then the unit will lock-out and indicate OVERCRANK.

**DIP Switches Detail**

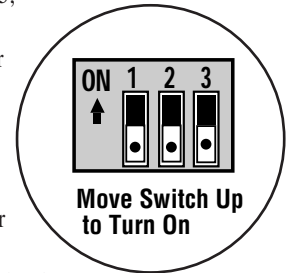

**DIP Switch Setting Charts**

*NOTE: Switches 1 and 2 are for Crank Attempt selection. Switch 3 is for Glow Plug or Warmup/Cooldown feature selection.*

Crank Attempts	Switch 1	Switch 2
3	ON	ON
5	ON	OFF
10	OFF	ON
Infinite	OFF	OFF

Feature	Switch 3
GLOW PLUG	ON
WARMUP/COOLDOWN	OFF

**SEQUENCE OF OPERATIONS**

**Sequence of Operations with Panel in "Auto"**

When the ASM160 receives an automatic start signal, the glow plug delay (if selected) begins timing and the glow plug output turns on. When the delay expires, the fuel and crank outputs turn on. When the engine starts, the glow plug output is turned off. At this time, the Shutdown Lockout and the Warmup Time Delay (if selected) will begin timing, and the starter will be disengaged. The Shutdown Lockout Delay serves a dual purpose. It causes the ASM160 to disregard the signals to the Oil Pressure and Engine Temperature inputs at engine start up. If the engine false starts before the delay expires, the engine will re-crank after a fixed delay (35 seconds), to let the engine stop moving before engaging the starter. When the delay expires, the Loss of Speed Signal shutdown is armed. Loss of Speed Signal occurs when both Overcrank and Overspeed LED's turn on if the speed drops below the crank disconnect set point.

When the Warmup delay expires, the "At Load" output turns on (if selected).

The spare shutdown on terminal 16 is locked out during the Shutdown Lockout Delay. The spare shutdown on terminal 17 is armed immediately. There is no LED annunciation for either of the spare shutdowns. They are reset by moving the Test-Off-Auto switch to Off position (breaking power) and back to Auto position.

If the engine speed exceeds the Overspeed set point (user adjustable), the ASM160 will signal the engine to shut down and annunciate Overspeed as the cause of shut-

down, and lockout the engine from any further start attempts. The Overspeed condition can be reset by moving the Test-Off-Auto switch into the Off position (breaking power) and back to Auto position.

If a Low Oil Pressure or High Engine Temperature shutdown condition occurs while the engine is running, the ASM160 will signal the engine to shut down and annunciate the failure on the appropriate LED. It will then lock out the engine from any further start attempts. Please note that the Shutdown Lockout Delay must have expired to get a shutdown on these functions. This is also reset by moving the Test-Off-Auto switch to Off to break power and back to Auto.

When the ASM160 receives an automatic stop signal from the remote start contacts, the "At Load" output turns off, and the Cooldown time delay (if selected) will begin timing. When this delay expires, the engine is signaled to stop.

**Sequence of Operations with Panel in "Test"**

When the Test - Off - Auto switch is placed in the "TEST" position, an automatic start signal is simulated. Therefore, the controller will operate the same as it does in "AUTO." However, it will continue to run as long as there are no signals from monitored conditions or until the Test - Off - Auto switch is moved to the "Auto" or "Off" positions. Keep in mind, it will still shut down the engine if a monitored condition occurs such as low oil pressure or high temperature.

## TROUBLESHOOTING INFORMATION



**WARNING:** Make sure voltage and current requirements are within the ASM160 ratings. Determine the polarity for the application. Use appropriate wire size for voltage and current. Do NOT route/bundle AC POWER wires with any other wiring.

*These instructions will assist in the correction of most problems which you may encounter with the unit. Before checking the list, first check all wiring and connections. If problems persist after the checks, consult any Murphy facility.*

<b>SYMPTOM</b>	<b>CORRECTIVE ACTION</b>
<b>When Test - Off - Auto Switch is placed in the TEST Position, nothing happens.</b>	Check your fuse to make sure it is good. Use a SFE 14 fuse. If good, check with a meter to see that battery (+) is present on middle terminal of toggle switch. Also, confirm voltage is present at terminal 10 when switch is in TEST position.
<b>Starter does not hold in long enough for the engine to start.</b>	Unit is possibly seeing a voltage drop. Ensure that battery is hooked directly to unit, 14 AWG wire is used, and no short circuits are present. Also make sure that the crank disconnect pot (R2) is turned up high enough.
<b>Odd, erratic behavior is noticed.</b>	Check to ensure that all alternator and ignition wiring is routed in a separate wiring loom from the rest of the control wiring. Also, confirm the use of shielded cable for the magnetic pickup. Resistor type spark plug wires and/or RF type spark plugs may be necessary for spark ignition engines.
<b>Unit shuts down on oil pressure soon after start.</b>	Check oil level. Shutdown lockout delay pot is fixed at 15 seconds to give engine time to develop oil pressure.
<b>Unit will not start when remote start / stop contact closes.</b>	Move panel mounted Test - Off - Auto switch to the "AUTO" position.
<b>Engine cranks but never starts.</b>	Make sure your fuel valve circuit is wired to terminal #1.
<b>Engine starts but green light blinks on briefly then goes out for 35 seconds. This occurs the same number of times set for crank attempts. Engine is then shutdown on Overcrank.</b>	Check to ensure Crank Disconnect adjustment is properly set. Refer to "Crank Disconnect (R2 Pot)" paragraph on page 3.
<b>Output appears not to function.</b>	Tighten connections to back of ASM160. Usually a good tight torque on the screw will solve this problem. You can verify operation by hooking a lamp to the suspect output.

### Warranty

A limited warranty on materials and workmanship is given with this FW Murphy product.  
A copy of the warranty may be viewed or printed by going to [www.fwmurphy.com/support/warranty.htm](http://www.fwmurphy.com/support/warranty.htm)



**FW Murphy**

P.O. Box 470248  
Tulsa, Oklahoma 74147 USA  
+1 918 317 4100 **fax** +1 918 317 4266  
**e-mail** [sales@fwmurphy.com](mailto:sales@fwmurphy.com)  
[www.fwmurphy.com](http://www.fwmurphy.com)

**INDUSTRIAL PANEL DIVISION**

P.O. Box 470248  
Tulsa, Oklahoma 74147 USA  
+1 918 317 4100 **fax** +1 918 317 4266  
**e-mail** [sales@fwmurphy.com](mailto:sales@fwmurphy.com)

**MURPHY DE MEXICO, S.A. DE C.V.**

Blvd. Antonio Rocha Cordero 300, Fracción del Aguaaje  
San Luis Potosí, S.L.P.; México 78384  
+52 444 8206264 **fax** +52 444 8206336  
Villahermosa Office +52 993 3162117  
**e-mail** [ventas@murphymex.com.mx](mailto:ventas@murphymex.com.mx)  
[www.murphymex.com.mx](http://www.murphymex.com.mx)

**FRANK W. MURPHY, LTD.**

Church Rd.; Laverstock, Salisbury SP1 1QZ; U.K.  
+44 1722 410055 **fax** +44 1722 410088  
**e-mail** [sales@fwmurphy.co.uk](mailto:sales@fwmurphy.co.uk)  
[www.fwmurphy.co.uk](http://www.fwmurphy.co.uk)



USA-ISO 9001:2000 FM 28221  
UK-ISO 9001:2000 FM 29422

Printed in U.S.A.

*In order to consistently bring you the highest quality, full featured products, we reserve the right to change our specifications and designs at any time.*